

E90**WOOD-COOKERS "ECO"**

mm 900x600xh860

CE EN -12815 certification

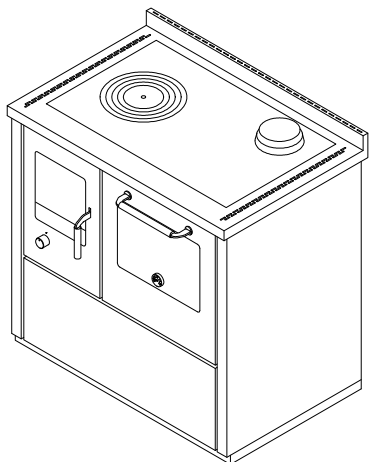

Colours:

White, Blue, Green, Grey, Black, Red, Ivory, Rust, Stainless steel

STANDARD EQUIPMENT

- right or left top flue outlet \varnothing 130 mm
- oven mm. 360x440xh260
- oven light and thermometer
- cast-iron hotplate mm 740x450 with cooking ring set
- black doors
- s.steel handles D3
- s.steel frame mm 40 (total height 860 mm)
- s.steel base h. 30 mm

BY REQUEST

- s.steel doors
- s.steel handles D1
- rear flue outlet, right or left \varnothing 130 mm
- glass-ceramic hotplate (rear flue exit)

OPTIONALS:

- frontal handrail, s.steel or brass, 2 or 3 sides
- heavy-duty radiant hotplate
- stainless steel hotplate cover

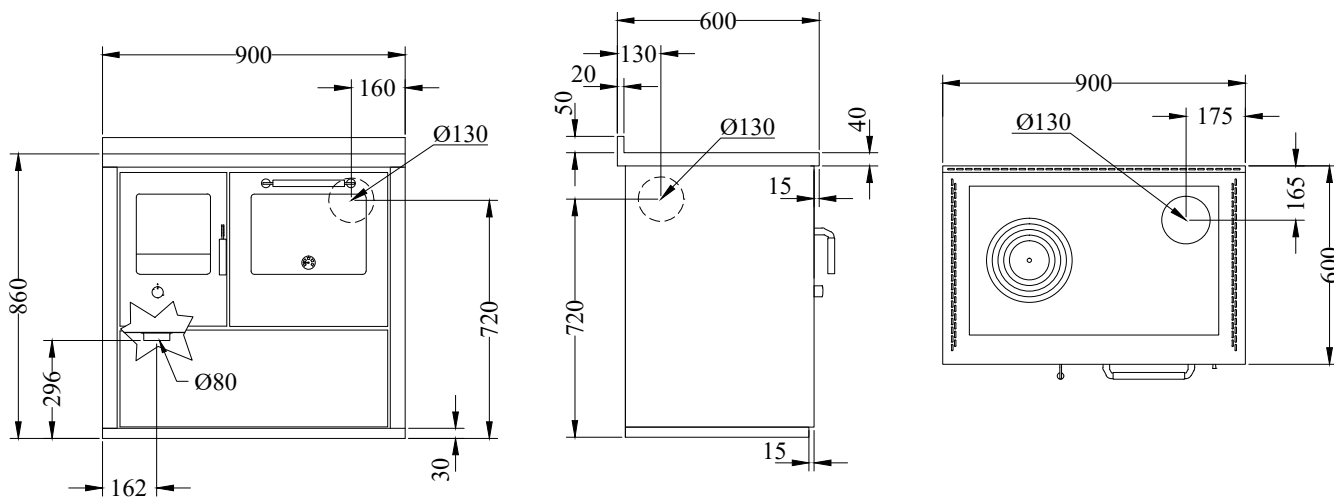

Right flue version. Left flue version is symmetrical

DATA SHEET

Nominal heat output: 6 kw	Efficiency: 85 %
Max heat output: 7.5 kw	Mean content of CO to 13% O ₂ : 0.09 %
Mean flue gas temperature: 224 C°	Flue gas mass flow: 7.0 g/s
Hearth dimensions (LxPxH): 21x40x31 cm	Average DUST content to 13% O ₂ : 28.7 mg/Nm ³
Fill opening (LxH): 22x25 cm	External flue air: \varnothing 80 mm
Flue depression: 0.12 mbar	Net weight/packaging included: 175/190 kg